



CPS Series

Wall-Mounted Power Supply Specifications

Project _____

Date _____ Type _____



CPS-12V-18W

Features

- 120 VAC input
- 5, 12, 24, 36, and 48 VDC output available
- 1-15P wall plug input, 5.5 mm barrel connector output
- Black or white case available on most models

Application

These power supplies are an excellent solution for powering low voltage LED lights such as strips and light bars.

Certifications and Compliances

CPS power supplies are UL Listed in compliance with UL 1310.



Warranty

Two (2) Year Warranty

Dimensional Drawing

Model	CPS-x-12W	CPS-x-18W	CPS-x-24W CPS-x-25W	CPS-x-36W	CPS-x-48W
A	1.5 in. (38 mm)	1.6 in. (40 mm)	1.7 in. (43 mm)	1.7 in. (43 mm)	1.5 in. (38 mm)
B	2.8 in. (72 mm)	2.9 in. (75 mm)	3.7 in. (93 mm)	3.7 in. (93 mm)	3.4 in. (86 mm)
C	48.5 in. (1.23 m)	48.5 in. (1.23 m)	48.5 in. (1.23 m)	48.5 in. (1.23 m)	47.5 in. (1.2 m)
D	1.7 in. (43 mm)	1.6 in. (41 mm)	1.8 in. (46 mm)	1.8 in. (46 mm)	1.9 in. (48 mm)

Available Models

5 VDC Output

- CPS-5V-12W
- CPS-5V-25W

12 VDC Output

- CPS-12V-12W
- CPS-12V-18W
- CPS-12V-24W
- CPS-12V-36W
- CPS-12V-48W

24 VDC Output

- CPS-24V-12W
- CPS-24V-18W
- CPS-24V-24W
- CPS-24V-36W
- CPS-24V-48W

Standard black case number shown. Add “(white)” to the end of 12 VDC or 24 VDC models for white case models.

Part Number Breakdown

Example: CPS-12V-18W

Family	Output Voltage	Output Wattage	Finish
CPS	5V [5 VDC] 12V [12 VDC] or 24V [24 VDC]	12W [12 W]	blank [black] or (white) [white]
		18W [18 W]	
		24W [24 W]	
		25W [25 W]	
		36W [36 W]	
		48W [48 W]	

Optional Accessories

- female 5.5 mm / 2.1 mm DC barrel connector (CPS-F2ST)

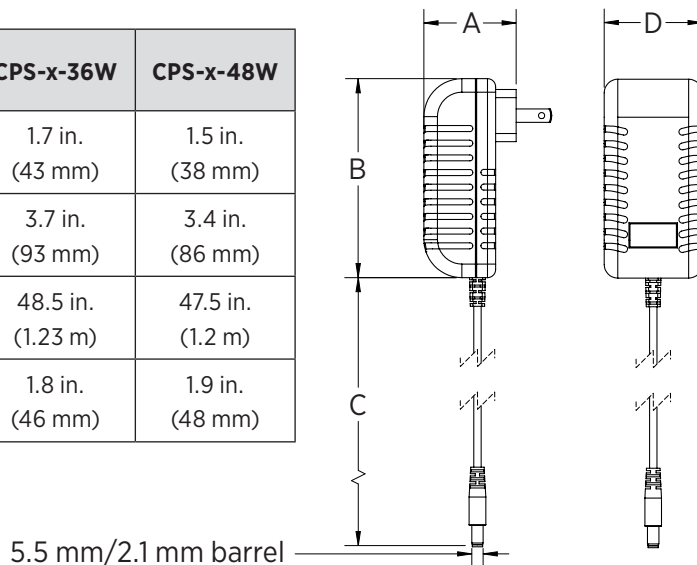



CVPSD Series

Wall-Mounted Power Supply Specifications

General Specifications (all models)

Model	CPS-x-12W	CPS-x-18W	CPS-x-24W	CPS-x-25W	CPS-x-36W	CPS-x-48W
Dimming	none					
Ambient Operating Temperature	32°-104° F (0°-40° C)					
Input Connection	1-15P (standard two-prong wall plug)					
Output Connection	DC barrel jack (5.5 mm / 2.1 mm)					

5 VDC Output Model Specifications

Model	CPS-5V-12W	CPS-5V-25W
Input Voltage	120 VAC	
Maximum Input Wattage	48 W	96 W
Maximum Input Current	0.4 A	1.2 A
Output Voltage	5 VDC	
Output Wattage	12 W	25 W
Maximum Output Current	2.4 A	5 A

12 VDC Output Model Specifications

Model	CPS-12V-12W	CPS-12V-18W	CPS-12V-24W	CPS-12V-36W	CPS-12V-48W
Input Voltage	120 VAC				
Maximum Input Wattage	48 W	48 W	96 W	144 W	144 W
Maximum Input Current	0.4 A	0.4 A	0.8 A	1.2 A	1.2 A
Output Voltage	12 VDC				
Output Wattage	12 W	18 W	24 W	36 W	48 W
Maximum Output Current	1 A	1.5 A	2 A	3 A	4 A

24 VDC Output Model Specifications

Model	CPS-24V-12W	CPS-24V-18W	CPS-24V-24W	CPS-24V-36W	CPS-24V-48W
Input Voltage	120 VAC				
Maximum Input Wattage	48 W	48 W	96 W	144 W	144 W
Maximum Input Current	0.4 A	0.4 A	0.8 A	1.2 A	1.2 A
Output Voltage	24 VDC				
Output Wattage	12 W	18 W	24 W	36 W	48 W
Maximum Output Current	0.5 A	0.75 A	1 A	1.5 A	2 A

Notes