

User Manual

RGB, CCT, or Single Color Dimming Bluetooth Controller



Safety and Notes

- Product should be installed and serviced in accordance with applicable national, state, and local building and electrical codes.
- To reduce the risk of electric shock, ensure that the main power source and circuit breakers are switched off before performing any installation or wiring procedures.
- Failure to properly secure controller, may result in damage or injury, for which the manufacturer does not assume responsibility.
- Intended for indoor use only.
- Auto-transmitting function relays signal to additional compatible controllers in 80 ft (25 m) range.

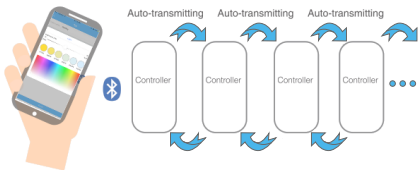

Controller Layout

Female DC Input Barrel Connector (5.5 mm x 2 mm) DC Input Screw Terminal Connection

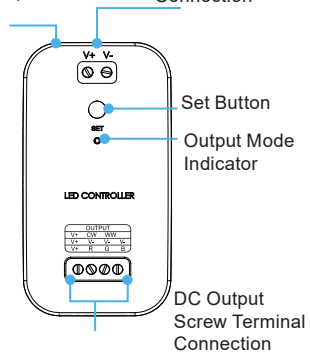

The output mode indicator will be **GREEN** when in single color dimming mode, **BLUE** when in CCT mode, and **RED** (make red) when in RGB mode. To switch between modes, simply hold the set button until output mode indicator changes color. Each time the mode on the controller is changed, the controller will need to be re-paired with account on phone/tablet.

Wiring Diagram

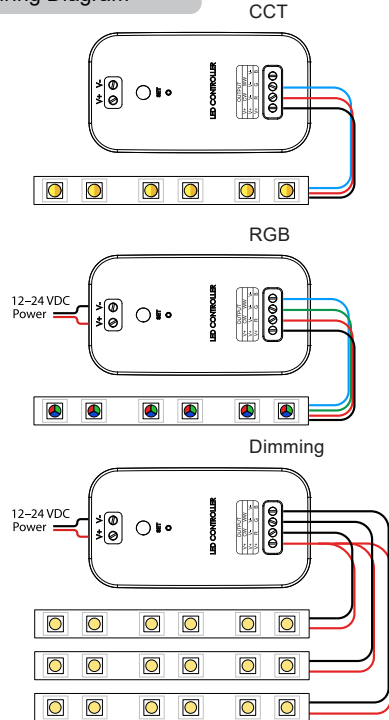

Downloading the App

The app can be downloaded by scanning the above QR code or by searching for "Open-Lit" in the Apple App Store or Google Play Store.



Phone/Tablet App Registration

1. Ensure Bluetooth is enabled on the device.
2. Open the app and select "Register" on the top right.
3. Select a password and email combo for account, then press "Register" button.
4. Return to home screen and log in.

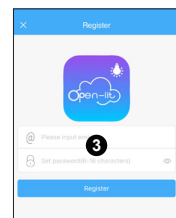
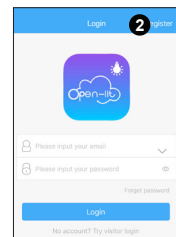

Note: Controller can only be paired to one account at a time. However, the same account can be used on multiple devices to access the same controller.

Pairing Controller to Phone/Tablet

1. Once logged in, and with device on the appropriate setting (RGB, CCT, or single color dimming), press "Add device" button.
2. Select "Add Bluetooth device" option.

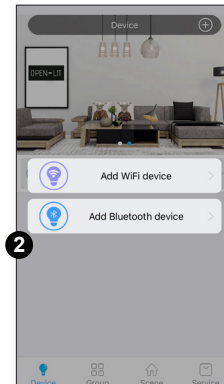
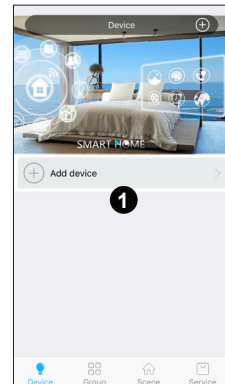

Pairing Controller (cont.)

3. A configuration screen will be displayed which will automatically pair the controller and the phone/tablet.
4. Once the process is finished, app will return to the home screen, where the controller will now appear.

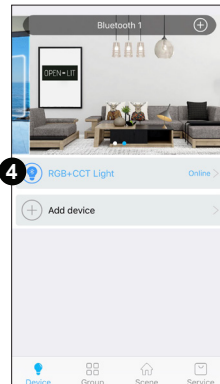
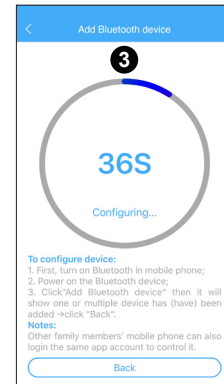

Note: Each time the mode on the controller is changed, the controller will need to be re-paired with account on phone/tablet.

Renaming or Removing Controller

Once a controller is successfully paired, the name of the paired controller can be changed by swiping to the left on the controller name and selecting “rename” button. Select the delete option to unpair the controller from the account.

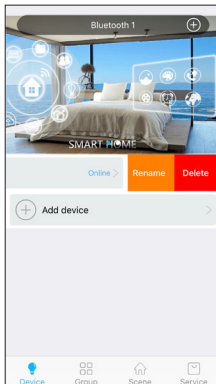

Light Function

In RGB mode, “Light” screen will display 6 presets for white (RGB) at various brightness levels at the top. The large rectangle below the 6 presets is used to control RGB color by sliding a finger across it. A brightness control slider and a master on/off button are also located on this screen.

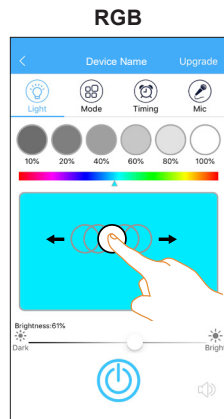

Note: RGB and white can not be used at the same time.

Light Function (cont.)

In CCT mode, there are 6 presets in a range from warm to cool which can be selected. Similarly, in single color dimming mode there are 6 brightness presets. A brightness control slider and a master on/off button are also located on this screen.

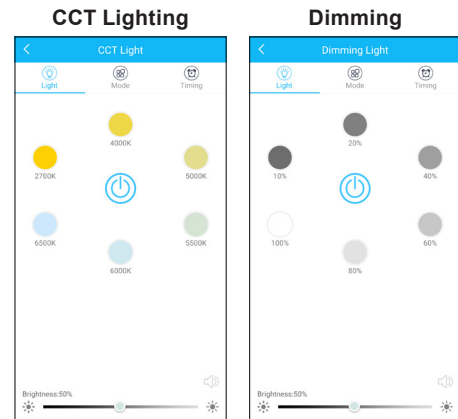

Mode Selection

In RGB mode, “Mode” screen will display 6 presets and 4 programmable patterns. There is a slider to control brightness and speed at the bottom of the screen. In CCT mode, this screen features 7 preset patterns. In dimming mode, this screen features 3 preset patterns.

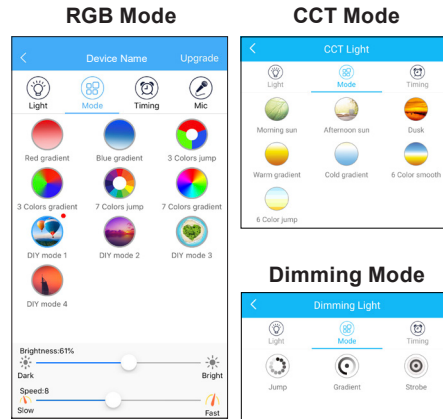

Mode Programming (RGB Mode only)

Each of the four programmable configurations in the “Mode” screen will allow up to 6 RGB colors and one of three patterns to be used to create custom modes.



Timing

Up to 16 on or off timer settings can be saved to automate controller function. The controller will remain on the same setting it was using previously when powered back on.

Mic (RGB Mode only)

When on the “Mic” screen the controller will use the microphone on the connected phone/tablet and will activate lights based on any sound picked up by microphone.

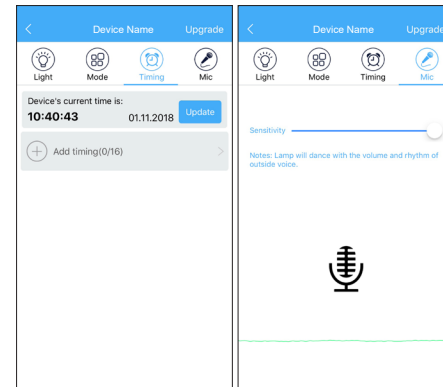

Specifications

Model	LF-BL-A3
Input Voltage Range	9–24 VDC
Output Voltage Range*	9–24 VDC
Max Input Current	3 A (Barrel Connector) 15 A (Screw Terminal)
Max Output Current	15 A (5 A per channel max)
Operating Temperature	-22°–131° F (-30°–55° C)
Max Recommended Communication Distance (varies by device)	80 ft (25 m)
Weight	1.75 oz (50 g)

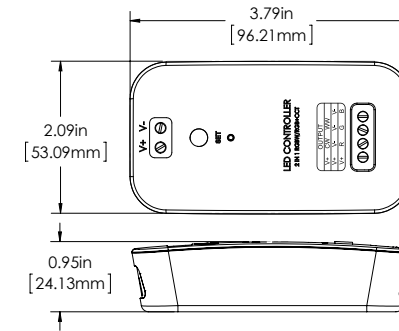

*Output voltage will not exceed input voltage.