

Strip CCT Options

- STN-A30K80-B6A-08B5M-24V-2-UC
- STN-A40K80-B6A-08B5M-24V-2-UC
- STN-A50K80-B6A-08B5M-24V-2-UC

SAMPLE PART NUMBER BREAKDOWN

STN-A30K80-B6A-08B5M-24V-2-UC

SERIES / TYPE / COLOR / CRI				LED TYPE / SEGMENT		IP RATING	SIZE / DENSITY / VOLTAGE				Kit
STN	A	30K	80	B	6	A	08	B	5M	24V	2-UC
Series	Strip Type	Color	CRI	LED Type	LED/Segment	IP Rating	Strip Width	Density	Length	Voltage	Kit Type
STN: Non-weatherproof	A: Single White	30K: 3000K 40K: 4000K 50K: 5000K	80: 80-84	B: 3528	6: 6 LED/seg	A: IP20	08: 8 mm	B: 60 LEDs/m	5M: 5 m	24V: 24 VDC	UC: Under Cabinet V2

Description

The under cabinet LED strip light kit was designed as an all-in-one lighting solution that provides professional-grade lighting with easy, DIY installation. The 80+ CRI provides accurate color rendering for residential or commercial task or ambient lighting. Customize using the cut segments and join with solderless clamps without wire stripping or splicing. Flexible construction and 3M™ adhesive backing make installing it on round surfaces and edges easy. Use the Wi-Fi + Bluetooth controller and the Smart Life app to adjust the brightness and switch between dynamic modes. For hands-free operation, pair the controller with an Alexa or a Google Assistant.

Electrical

- 24 VDC input
- PWM dimmable

Photometrics

- 120° beam angle
- 80+ CRI

Warranty

Five (5) year warranty

Applications

This strip light kit is ideal for kitchen lighting applications, including under-cabinet and interior cabinet illumination, above-cabinet ambient lighting, and toe-kick accent lighting.

Certifications and Compliances

These strips are UL Listed in compliance with UL 2108 standards.



What's Inside:

- (5 m) Single-Color LED Strip Light - 24V - 150 lm/ft
- (1) Wi-Fi/Bluetooth Single-Color LED Controller - Alexa/Google Assistant/Smartphone Compatible
- (1) 36 W 24 VDC Power Supply
- (1) Standard Barrel Connector to Wire Adapter
- (14) Solderless Clamp-On Pigtail Adapters
- (10ft) 22 AWG Two Conductor Power Wire
- (4) 3M™ Wire Nuts - 22-16 AWG
- (2) 3M™ Double-Sided Foam Pads



T 866.811.5550

F 314.972.6202

email: commercial-sales@superbrightleds.com

https://www.superbrightleds.com/cat/complete-led-strip-kits/

Rev. V1 Date: 4/8/2024

Specifications are subject to change without notice.

Printed in the U.S.A.

STN Series

Under Cabinet LED Strip Light Kit Specifications

Dimensional Drawings

LED Strip

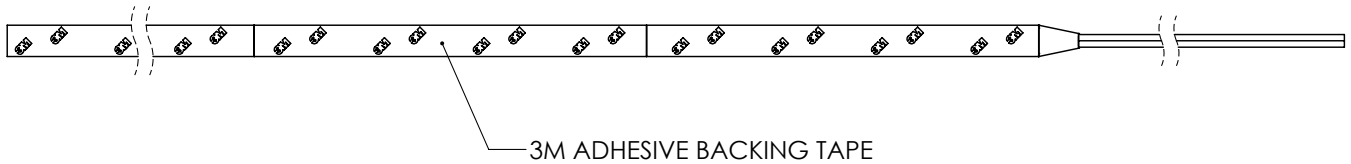
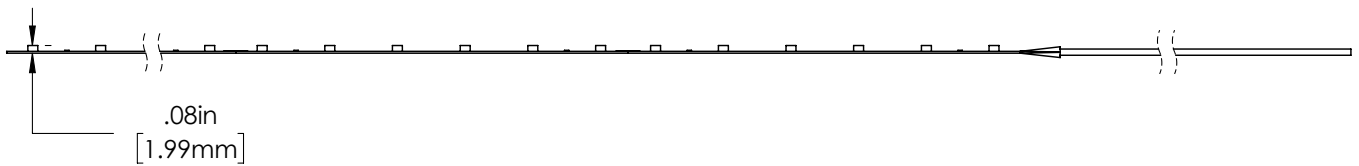
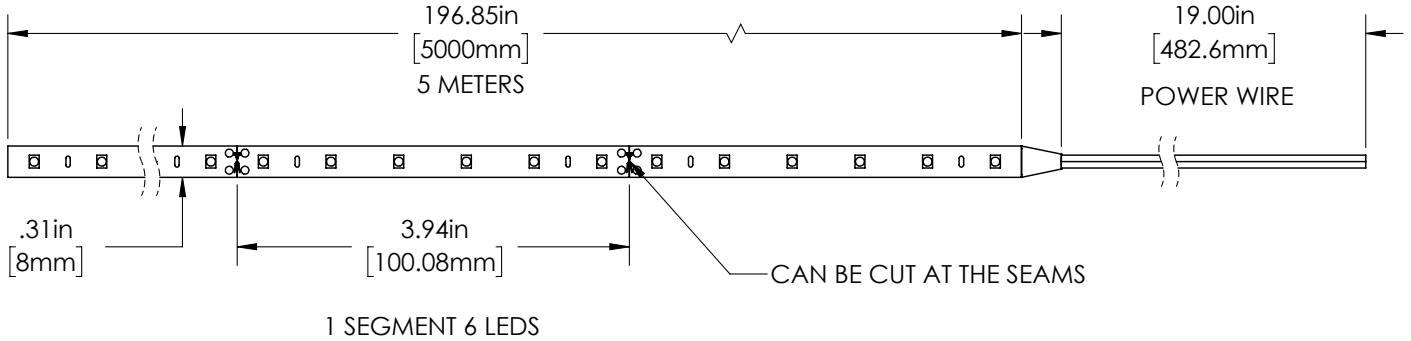

Dimensional Drawings

Power Adapter

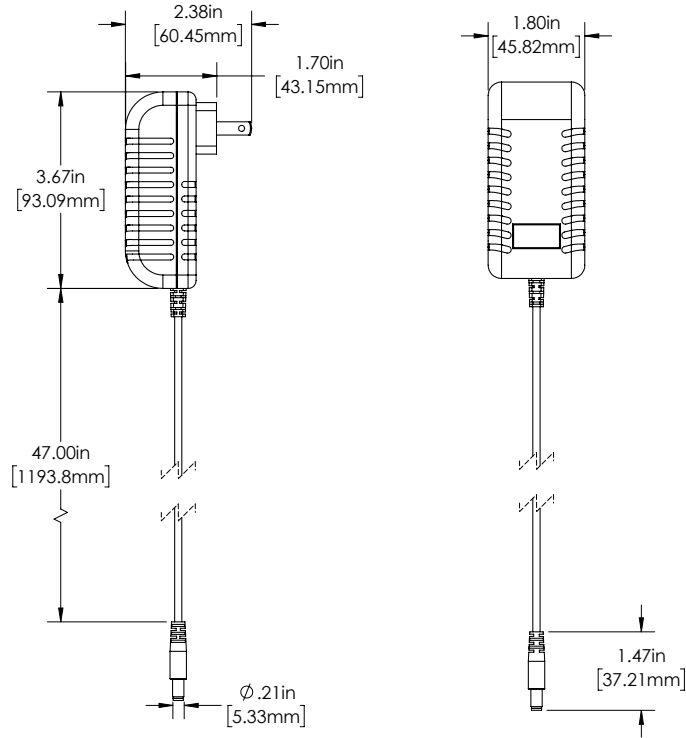

LED Controller

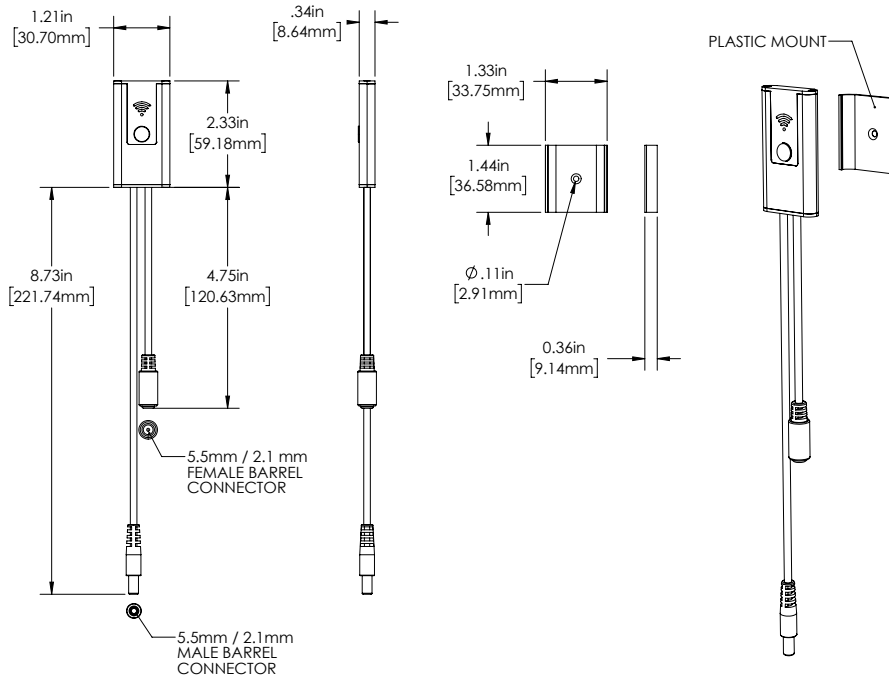

STN Series

Under Cabinet LED Strip Light Kit Specifications

Specifications

Strip Specifications	
Beam Angle	120°
Brightness	150 lm/ft (492 lm/m)
Connection Type	Pigtail
CRI	80+
Dimmable	Yes
Input Voltage	24 VDC
IP Rating	IP20
LED Density	18 LEDs/ft (60 LEDs/m)
LED Lifetime	50,000 hours
LED Type	3528 SMD
LEDs per Segment	6
Length	16.4 ft (5 m)
Minimum Cut Length	3.9 in. (100 mm)
Max Run	Up to 41 ft (12.5 m)
Strip Width	0.31 in. (8 mm)
Wattage Per Foot	1.4 W/ft (4.7 W/m)
Wattage Total	22 W
Wire Length	20 in. (508 mm)
Standards And Certifications	UL Listed, CE, RoHS Compliant
Single White CCT Options	Warm: 2400K or 3000 Natural: 4000K Cool: 5000K or 6500K

Controller Specifications	
Input Connection	5.5mm Barrel Connector
Control Range	Up to 82 ft (25 m)
Input Voltage	12-24 VDC
Output Voltage	12-24 VDC
Rated Current	3 A @ 24 VDC, 6 A @ 12 VDC
IP Rating	IP20
Remote Type	Smart Life app (Bluetooth/ Wi-Fi) Alexa and Google Assistant compatible

Power Adapter Specifications	
Input Connection	1-15P Plug
Input Voltage	120 VAC
Output Connection	5.5 x 2.1 mm Barrel Connector
Output Voltage	24 VDC
Standards And Certifications	UL Listed, FCC, RoHS
Wattage	36 W
IP Rating	IP20
Cord Length	47 in. (119 cm)

STRIP FLEXIBILITY

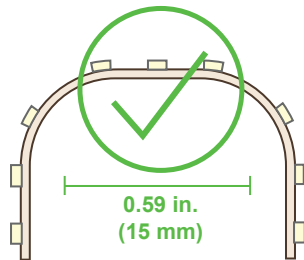

Bends less than 15mm will damage circuit traces and void warranty.

Bending strips at sharp angles will damage circuit traces and void warranty.

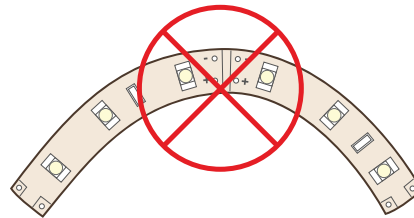
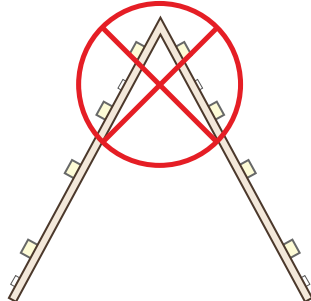

Bending strips on horizontal plane will damage circuit traces and void warranty.

